

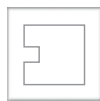

CNC

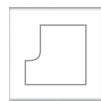

Grooving & Sizing



Profiling & Chamfering

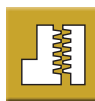

Jointing & Rebating



Frame & Panel door



Carving



Clamping Systems & Adapters



Saving



CNC



Cutting



Drilling

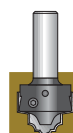

Routing

Plastic, Corian, Aluminum

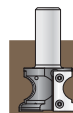

Custom Tooling

Finger Joint Router Cutter

Disposable insert finger jointing router cutter complete with two cutting flutes. Suitable for producing finger joints in softwoods, hardwoods and man-made boards. For use on routers and machining centres with CNC control.

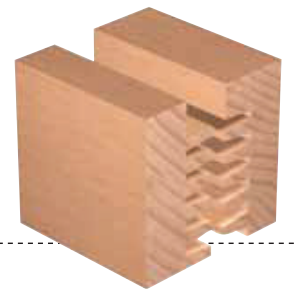
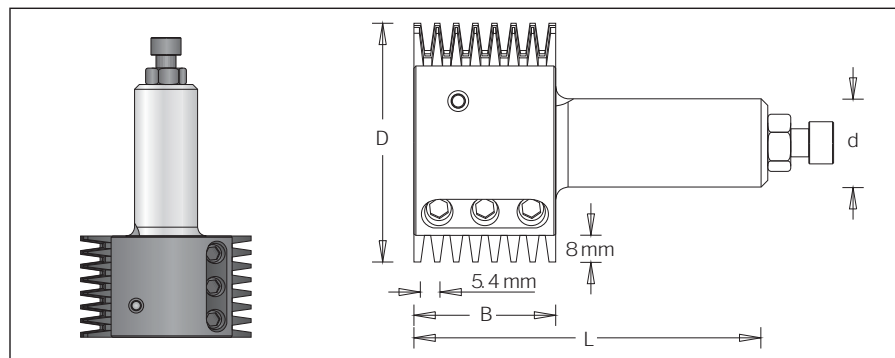

$\varnothing D$	Code No.	B	L	$\varnothing d$	n
70	856 011 0	40	100	25	12,000

⚠ Also available with 20 mm diameter shank

Spare Parts



T.C. Blade
315 650 2
40x28x1.5



Supporting plate
199 110 1
40x22.5x4



Allen screw
193 040 0
M8x10



Wedge
199 022 0
40x13.5x8



Allen key
194 015 0
S-4

