

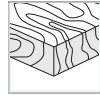

Sawing

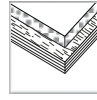

Solid Wood



Boards



Plastic

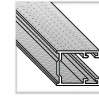

Aluminium

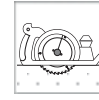

Sawblade for Portable Machines



MU P - Plastic Trimming & Sizing Saw Blade

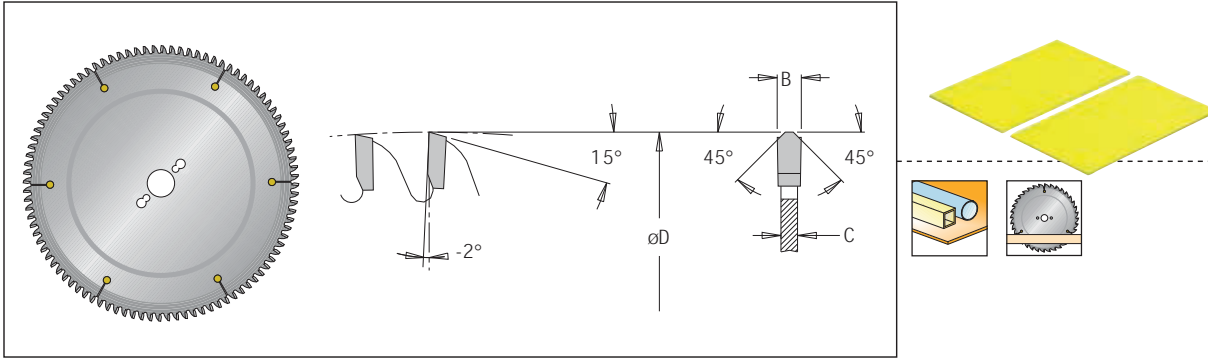

øD	Teeth	Code No.	B	c	ød
250	80	901 07 03 6	2.5	1.8	30
300	96	901 07 06 6	3.3	2.6	30
350	108	901 07 09 6	3.7	3	30

Manufacturing Technology:



Dynamic Straightness

Index

Sawing



CNC

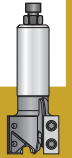

Cutting



Drilling

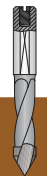

Routing



Plastic, Corian, Aluminium

Custom Tooling

